

# Roller Blind



- Functional and economical Roller Blind System.
- Smooth operation.
- Widest Range of Fabric Designs.
- Easy lift of large sizes with the help of spring.
- Bottom rail can be covered for better aesthetics.
- Reliable clutch for a trouble free operation.
- Valance can be used for protection against sunlight and better aesthetics.
- Possible to use side rails to create a blackout.

# Roller Blind

## Roller Blind with valance



## Structure Drawing

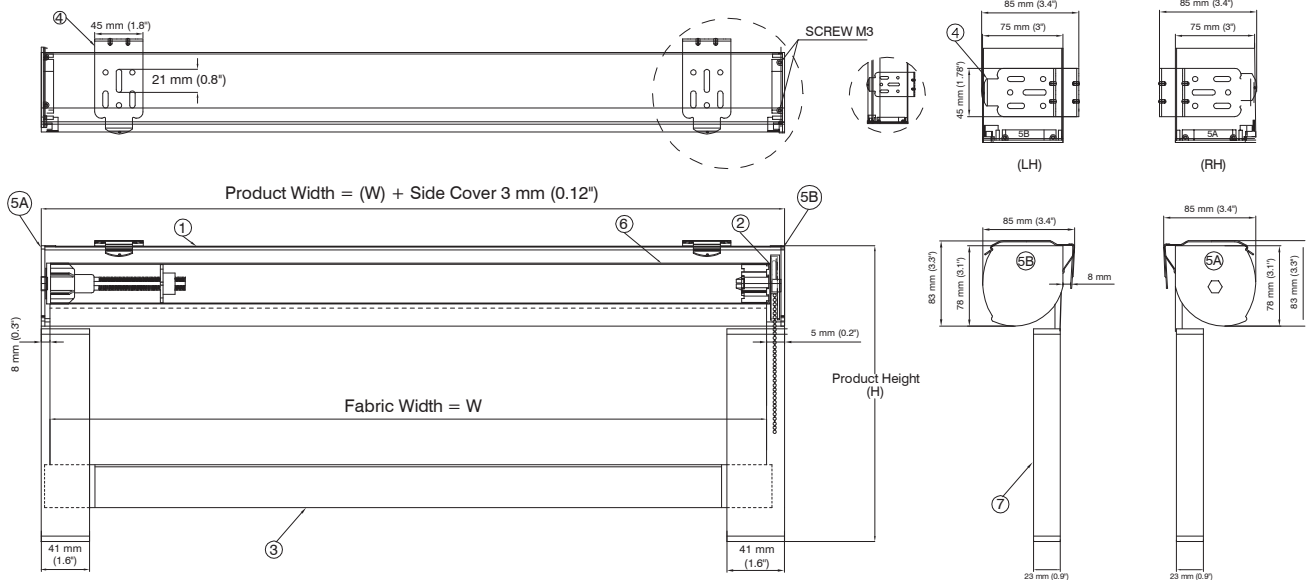

## Installation Dimensions

### Wall Attachment

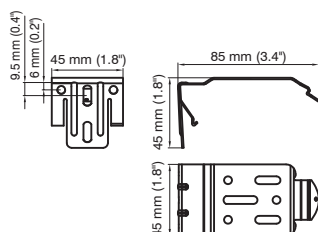

### Ceiling Attachment

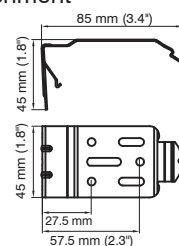

### Components and Materials

No.	Components	Material
①	Head Rail	Aluminum
②	Clutch	Polyacetal resin
③	Bottom Bar	Aluminum
④	Bracket	Steel
⑤	5A- Side End cap 5B- Side End cap	Polyacetal resin
⑥	Tube	Aluminum
⑦	Side Guide	Aluminum

## Roller Blind without valance

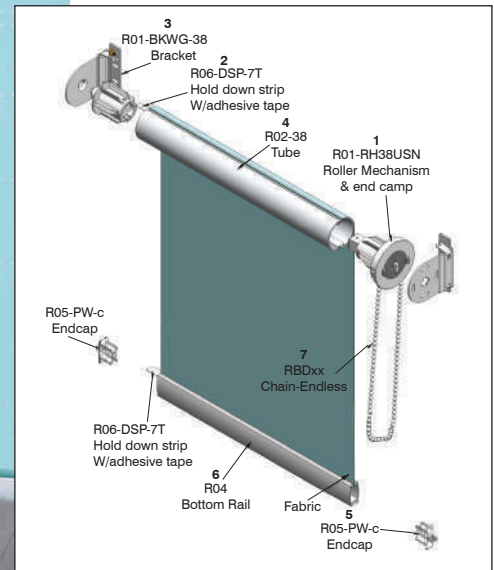

## Structure Drawing

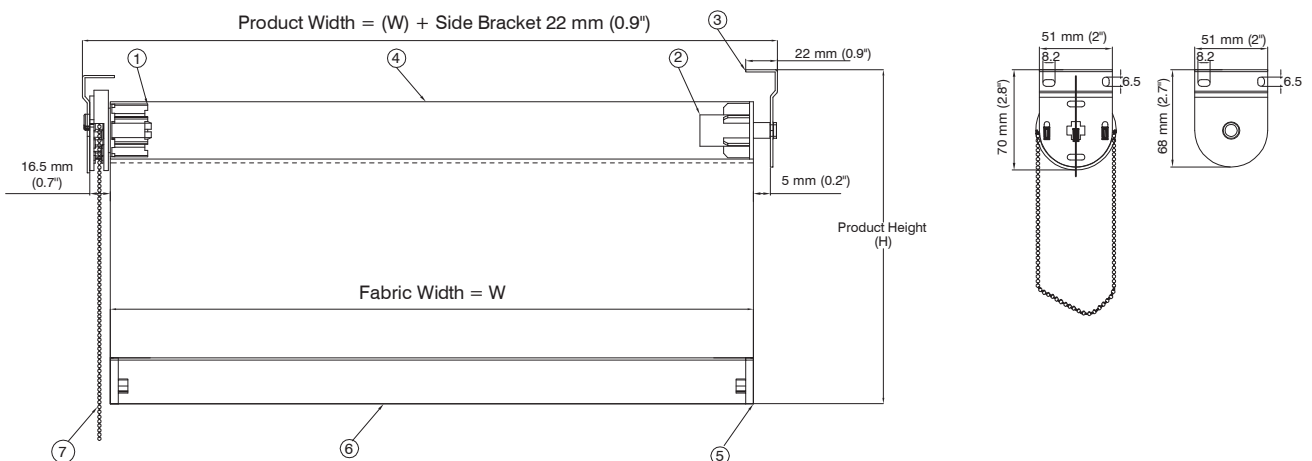

## Installation Dimensions

### Wall Attachment

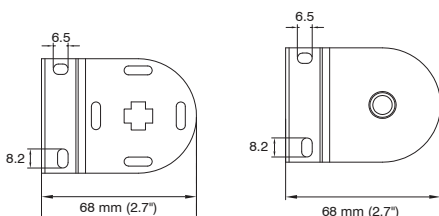



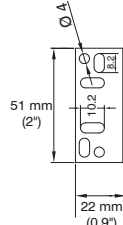





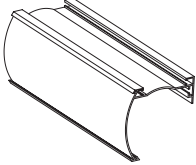

### Ceiling Attachment

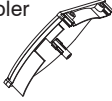
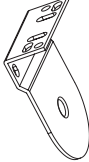

## Components and Materials

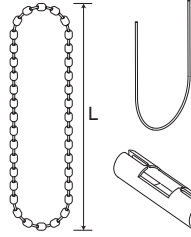
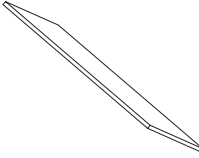
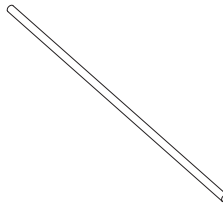
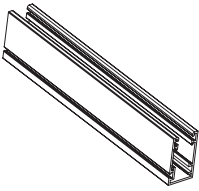
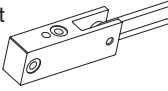
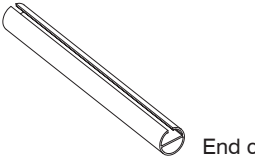
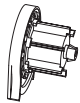
No.	Components	Material
①	Clutch	Polyacetal resin
②	End cap	Polyacetal resin
③	Bracket	MS
④	Tube	Aluminum
⑤	Bottom Rail End cap	Polyacetal resin
⑥	Bottom Rail	Aluminum
⑦	Ball Chain	Polyester

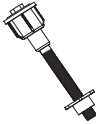
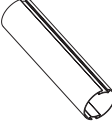
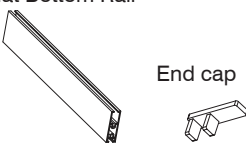
## Roller Blind Parts

Product Name	Size	Product Code	Product Name	Size	Product Code
Head Rail (4 m) 	74 x 70 mm	SCAS-NS650	End cap 	40 x 40 x 100 mm	R01-G3806F2
Bracket 	43.4 x 45 x 82.3 mm	SBKT-SW65N	Bracket 	51 X 22 X 68 mm	R01-BKC-38
End Cap Controller 	69.8 x 76 x 25.1 mm	SCEC-NR65R	Bracket 	51 x 22 x 68 mm	R01-BKC-38
End Cap 	69.8 x 76 x 25.1 mm	SCEC-NR65L	Clutch 	40 x 40 x 120 mm	R01-G3806F2
Ball Chain & Cord 	L=3 mtr	RBD30-C	Spline 	8.7 mm x 150 mtr	SSPL-S0087
	L=2.5 mtr	RBD25	Rod 	4 mm x 4 mm	RR-4400
	3.2 mm	SCOR-EL320	Side Guide Rail 	41 x 23 mm	RSG-4123
Cord Weight 			Round Bottom Rail 	21.5 x 1 mm	R-3352
Clutch 	50.3 x 59 x 40.8 mm	SCLU-S38AS	End cap 		
Limit Assembly 	37 x 37 x 107.3 mm	SLIA-3D380			
Tube 	38 x 38 mm 38 x 38 mm 38 x 38 mm	R3301-1 STUB-2H380 STUB-1H380			
Flat Bottom Rail 	35 x 9 mm	RFB 3509			
Oval Bottom Rail 	32 x 16 mm	ROB-3216			